

## Peak Emission Wavelength: 310nm

The MTSM3080HSF-UV is a powerful, small-footprint UV-B emitting device. A peak wavelength of 310nm LED creates new feasibility for a variety of applications. This UV Emitter is in a Seam Welded Surface Mount package for applications requiring high output power and efficiency.

### FEATURES

- > 5mm x 5mm Seam Welded Surface Mount Package
- > High Reliability
- > High Output Power
- > Hermetically Sealed Package

### APPLICATIONS

- > Medical Phototherapy
- > Protein Analysis
- > Drug Discovery
- > Forensic Analysis

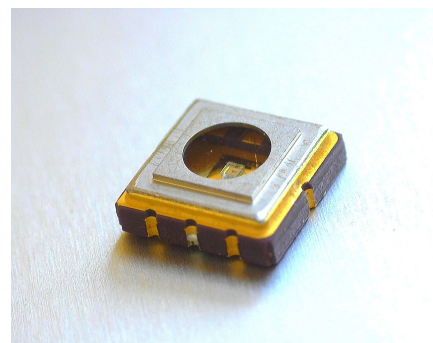

## Absolute Maximum Ratings (Ta=25°C)



ITEMS	SYMBOL	RATINGS	UNIT
Forward Current	IF	100	mA
Reverse Voltage	VR	TBD	V
Power Dissipation	PD	TBD	mW
Operating Temperature	Topr	-20 ~ +85	°C
Storage Temperature	Tstg	-30 ~ +100	°C

## Electrical & Optical Characteristics (Ta = 25°C)

ITEMS	SYMBOL	CONDITIONS	MIN.	TYP	MAX.	UNIT
Forward Voltage	VF	IF=20mA	--	4.65	--	V
Peak Wavelength	$\lambda_p$	IF=20mA	--	310	--	nm
Radiant Flux	PO	IF=20mA	--	1.95	--	mW
FWHM	$\Delta\lambda$	IF=20mA	--	18	--	nm
View Angle	$\Theta$	IF=20mA	--	110	--	deg

Package Dimensions

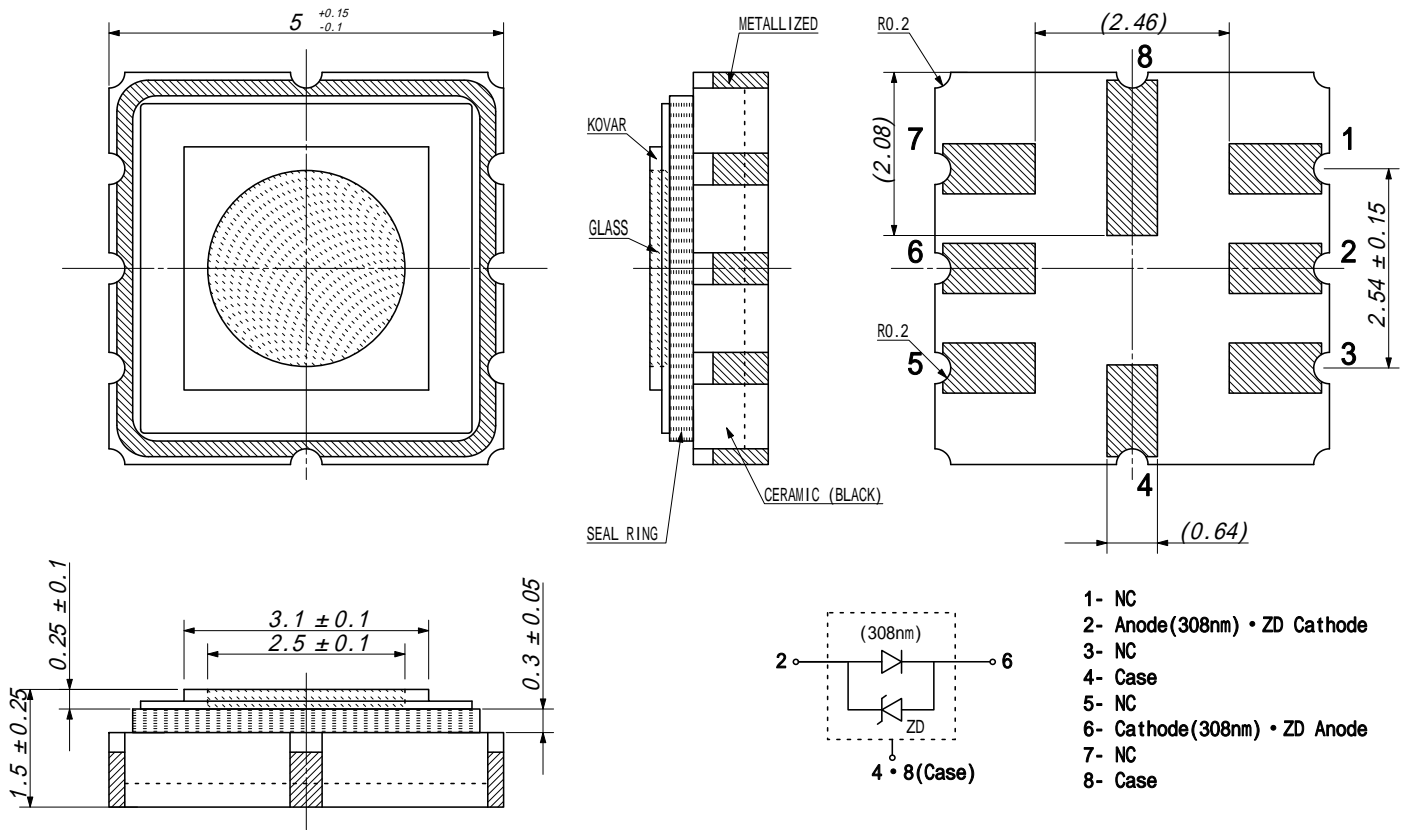

Recommended Soldering Pattern [mm]

Reflow Soldering Temperature-Profile [Pb free Soldering] (Recommend condition)

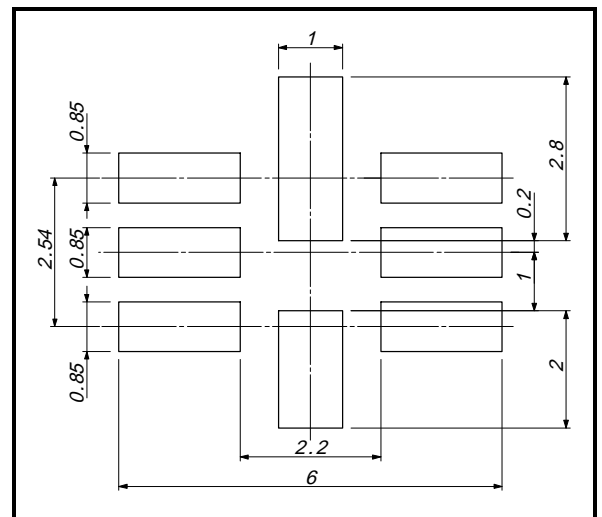
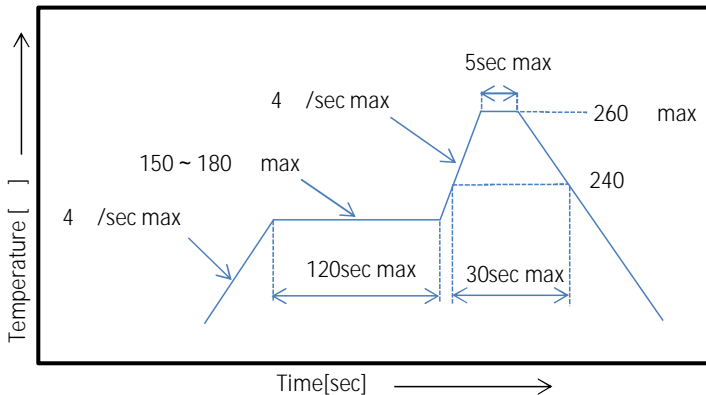

Spectral Response

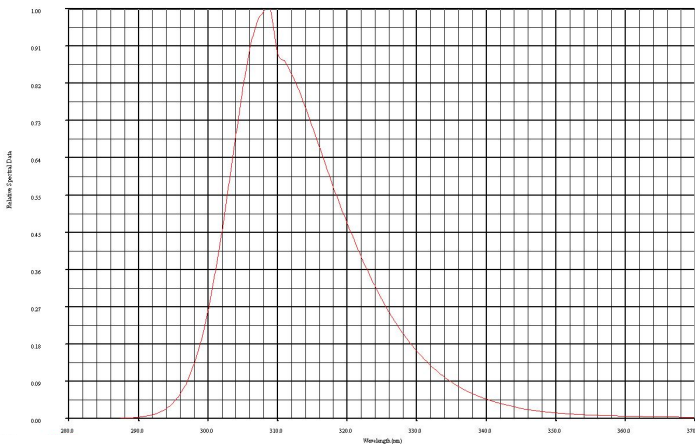

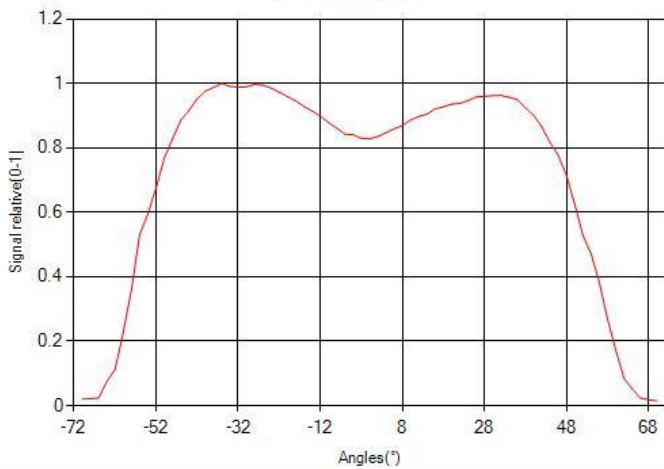

Radiation Distribution

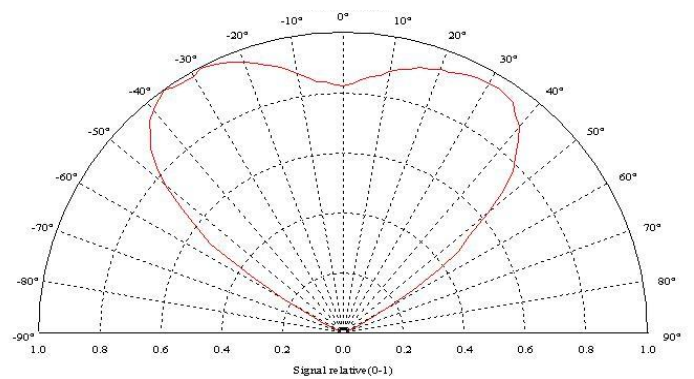

View Angle

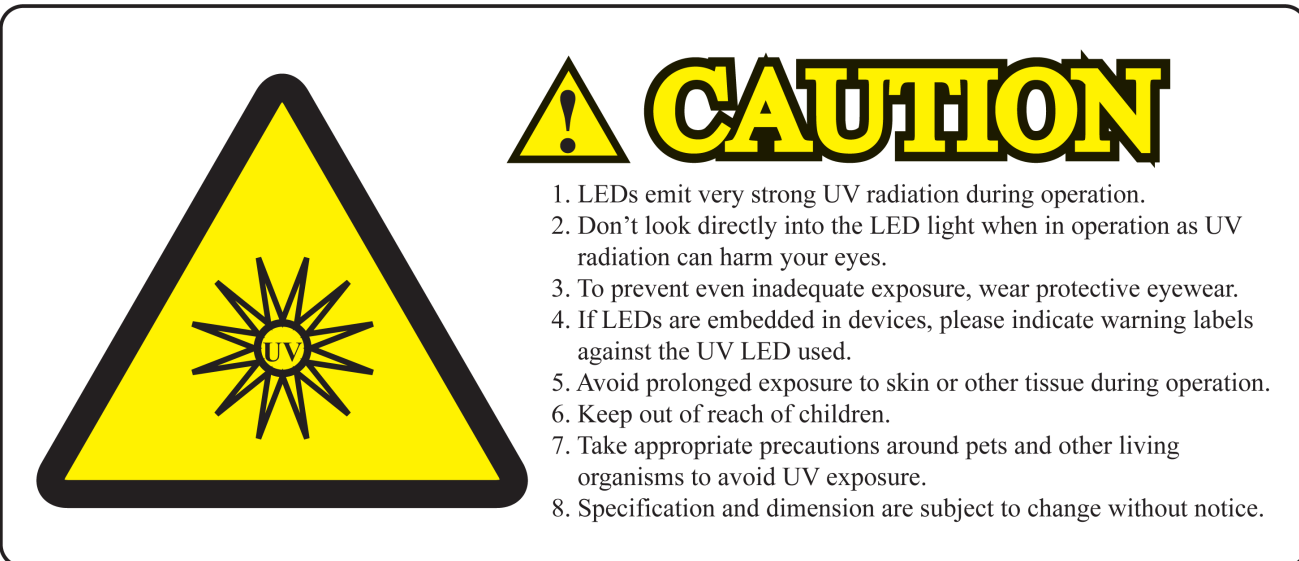



 **CAUTION**

1. LEDs emit very strong UV radiation during operation.
2. Don't look directly into the LED light when in operation as UV radiation can harm your eyes.
3. To prevent even inadequate exposure, wear protective eyewear.
4. If LEDs are embedded in devices, please indicate warning labels against the UV LED used.
5. Avoid prolonged exposure to skin or other tissue during operation.
6. Keep out of reach of children.
7. Take appropriate precautions around pets and other living organisms to avoid UV exposure.
8. Specification and dimension are subject to change without notice.