

Peak Emission Wavelength: 235nm

The MTE2350F-UV2 UV emitter is a specifically designed for applications requiring high radiant power output and accuracy in a TO-39 package with a special UV glass lens for optimum life time and device performance. Custom package solutions and sorting are available.

FEATURES

- > Dual UV Die in a TO-39 Metal Can Package
- > High Reliability
- > Narrow Viewing Angle
- > Silanna Safe

APPLICATIONS

- > UV Curing / Light Therapy / Drug Discovery
- > Air and Water Disinfection
- > DNA / Protein Analysis

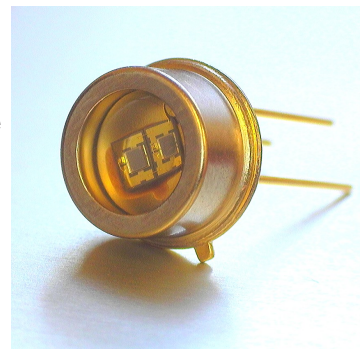

Absolute Maximum Ratings (Ta=25°C)



ITEMS	SYMBOL	RATINGS	UNIT
Forward Current	IF	100	mA
Operating Temperature	Topr	TBD	°C
Storage Temperature	Tstg	-40 ~ +100	°C
Junction Temperature	Tj	60 (TBD)	°C
Soldering Temperature*1	Tsol	300	°C

*1: Within 5 seconds.

Electrical & Optical Characteristics (Ta = 25°C)

ITEMS	SYMBOL	CONDITIONS	MIN.	TYP	MAX.	UNIT
Forward Voltage	VF	IF=40mA	--	5.75	--	V
Peak Wavelength	λ_p	IF=40mA	230	235	240	nm
Power Output	PO	IF=40mA	--	0.62	--	mW
Spectral Line Half Width	$\Delta\lambda$	IF=40mA	--	9	--	nm
View Angle	Θ	IF=40mA	--	100	--	deg

Package Dimensions

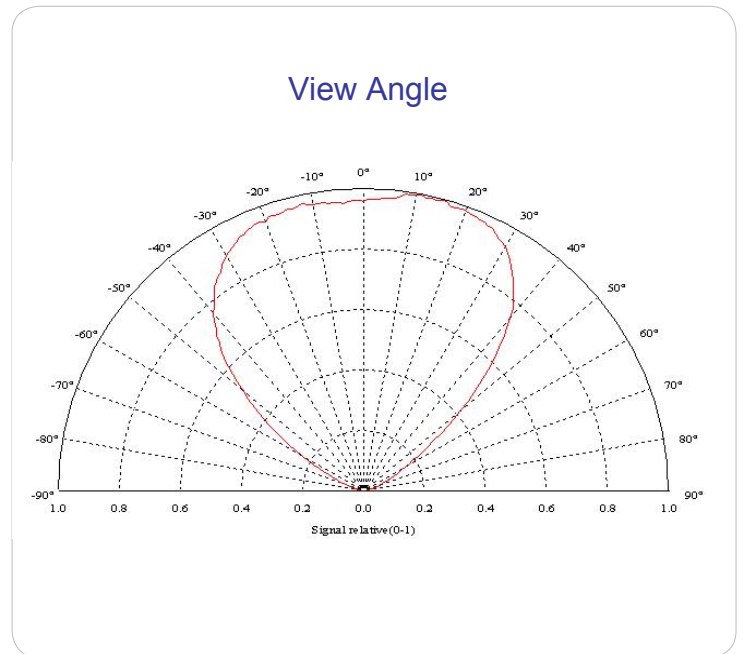
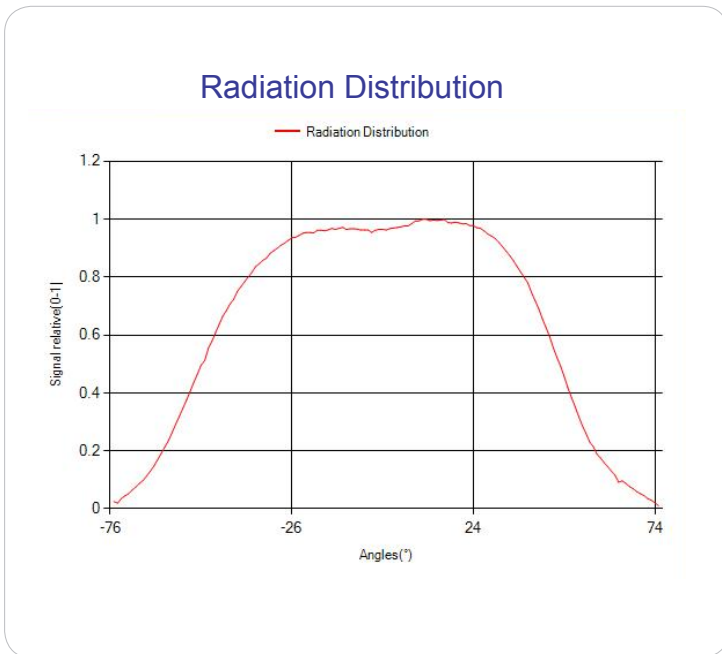
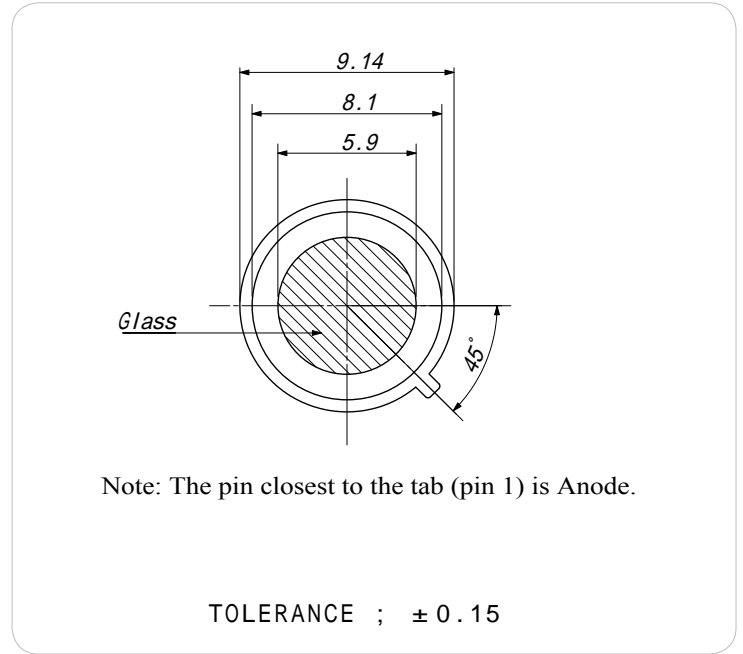
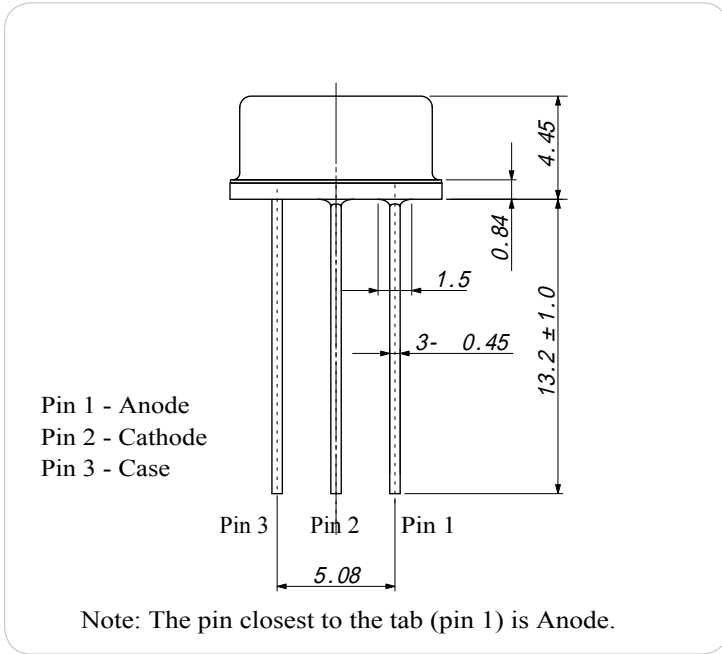



Unit: mm

2024-03-28

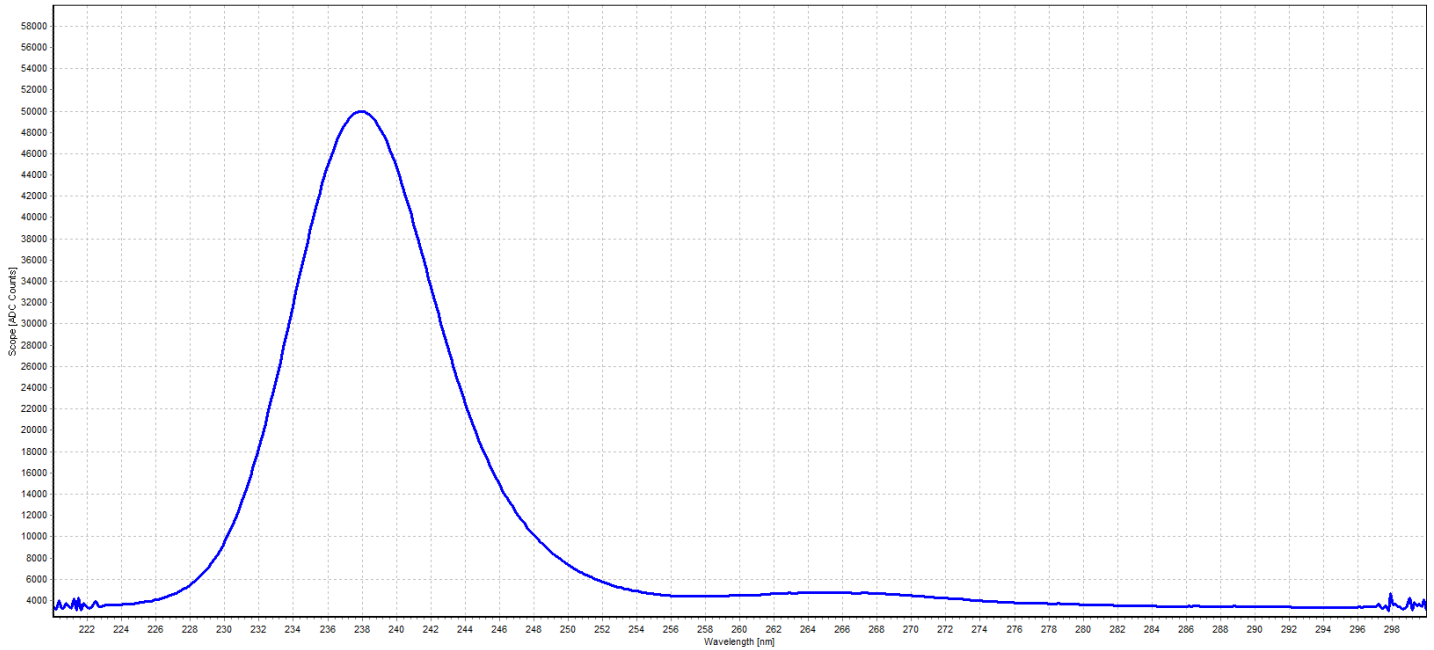
Spectral Response





 **CAUTION**

1. LEDs emit very strong UV radiation during operation.
2. Don't look directly into the LED light when in operation as UV radiation can harm your eyes.
3. To prevent even inadequate exposure, wear protective eyewear.
4. If LEDs are embedded in devices, please indicate warning labels against the UV LED used.
5. Avoid prolonged exposure to skin or other tissue during operation.
6. Keep out of reach of children.
7. Take appropriate precautions around pets and other living organisms to avoid UV exposure.
8. Specification and dimension are subject to change without notice.